

METER SOCKET ADAPTERS

Presentation for WI Distributed
Resources Collaborative

PRESENTERS

Emily Peck, Policy Manager

Mykah Smith, Product Support Trainer

4 / 18 / 2025





- Wisconsin IOUs do not currently have clear guidelines on Meter Socket Adapters (MSAs), which means customers cannot access this type of technology
- We aim to inform the WIDRC group on MSAs as a class of customer-owned devices
- We share how other states and utilities have adopted MSA processes, and encourage WI utilities to consider approving MSAs for customer use in your region

1 Product Overview

What is a meter socket adapter? How does it work?

3 Next Steps

What process does a utility typically follow when they review and approve MSAs?

2 MSA Approval Landscape

Where have MSAs been approved?
Where does Wisconsin stand?

4 Questions

Time for input and questions from the audience

Contents

Product Overview

01



What is a Meter Socket Adapter (MSA)?

- A meter socket adapter (MSA) is a device that installs between an electric meter socket and a utility billing meter.
- All MSAs have a plastic housing with copper conductors passing the energy being delivered from the utility through the meter and into the home.
- Various OEMs produce devices with different applications, such as surge suppression, generator backup, and DER interconnection (rooftop solar, EV chargers, batteries)
- MSAs form an elegant, dedicated point of interconnection for customer-owned devices on the load side of the meter.



ConnectDER Solar MSA



Tesla Backup Switch MSA



Generlink MSA

Solar MSA



Key Features

- Rated for use in up to 200 Amp services
- 15-80 Amp circuit breaker options
- Up to 15.36 kW PV Solar
- 22k AIC / AIR rating
- 2S / 12S meter forms and sockets

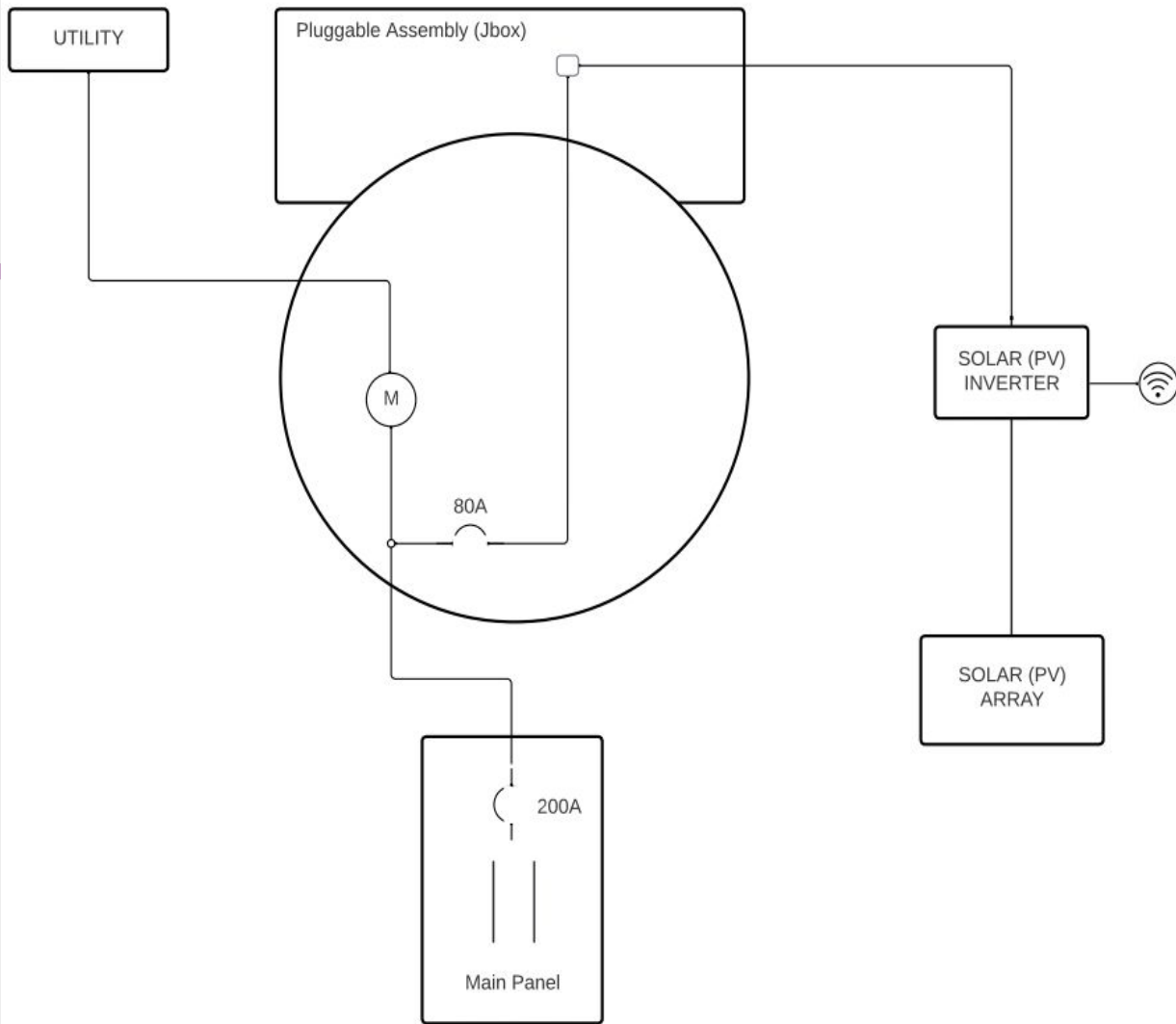

Installation Video

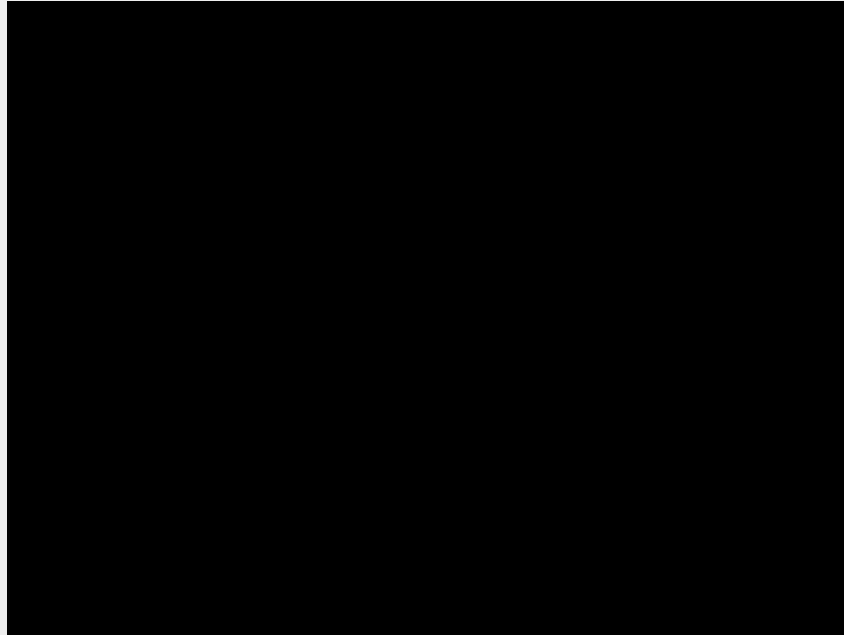

EV MSA - EVSE Supply Side Connection

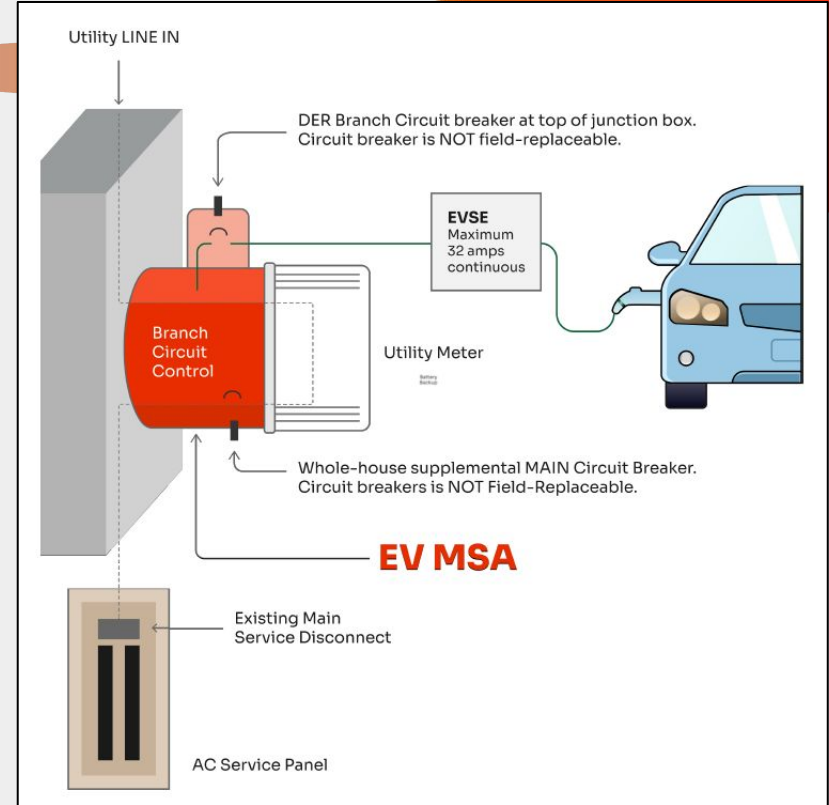
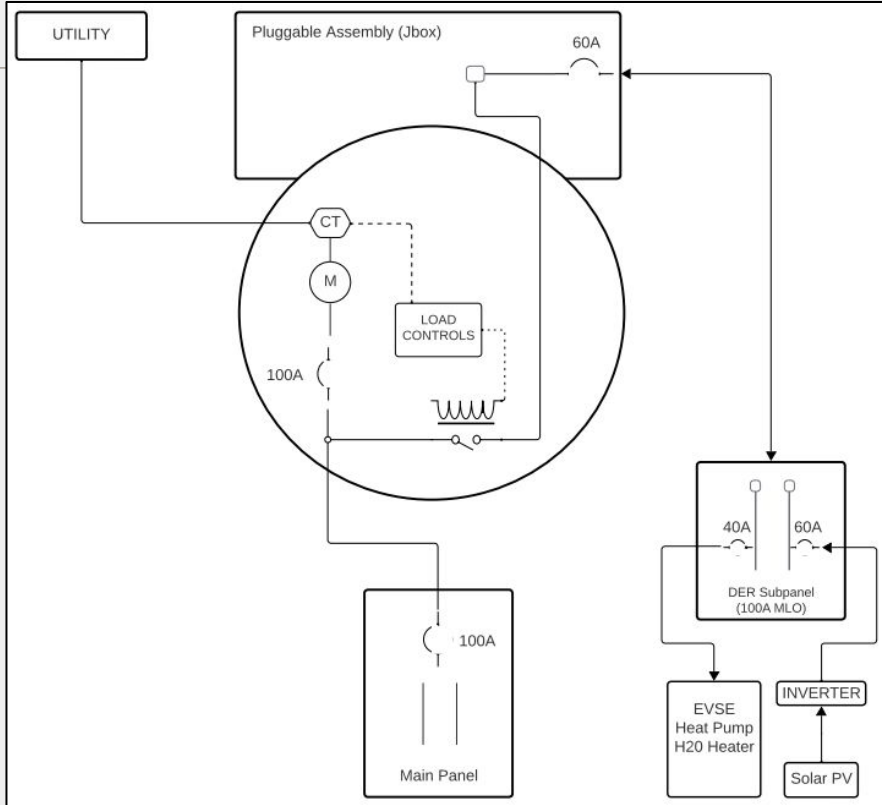

Installing an EV MSA at home

“The meter engineer asked me to test the relay by pulling enough current to make it open. Took every load in my house to trip the relay, including my wife baking sourdough in the electric oven, 2 window AC units, pool pump, electric dryer, electric hot water heater, space heater...oh and charging the EV! Almost couldn't do it, but finally got the click and solid red lights.”

Real world example reflects study findings on 100A capacity - The vast majority of homes use less than 50% of their panel's electric capacity on a regular basis.

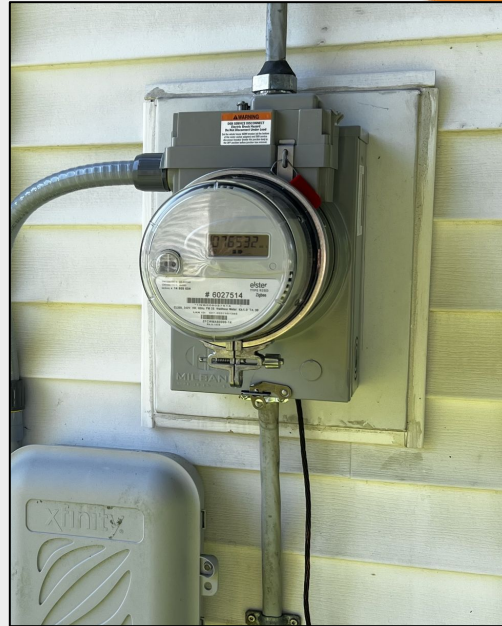

IslandDER MSA for Battery Backup

- Facilitates whole-house and partial backup power behind the meter
- Comprising main housing (MSA Base) and pluggable data and/or power assembly (MSA Connection Module) for connections to partner battery system equipment
- Provides:
 - Whole-house disconnect (MID)
 - Voltage and current sensing
 - Data cable with analog signals or digital communications to 3rd party equipment

Benefits of MSAs

- Expensive electrical service work is avoided
 - Avoiding a main panel replacement saves \$2,000-\$5,000 per home, avoiding service upsizing can save even more
 - Equity & Access - levels playing field, income, housing type.
- Safe, consistent, reliable, repeatable installation process
- Disruption is minimized – very short install time, outdoor installation.
- Customer-owned device = no impact to rate base.
- Minimal lift for utility crews
 - In most jurisdictions, third-party installer electricians complete the MSA install after notifying the utility through standard forms

UTILITIES have ambitious goals around increasing **RESILIENCY AND CONSUMER CHOICE**

Improve Equitable and Affordable Options

Electrification is more challenging for lower and middle income customers. Adoption of technology can allow more flexibility and options for electrification.

Enhance Customer Satisfaction

Wisconsin utilities look to develop new programs and employ technologies that enhance customer satisfaction

Prepare for load growth

With increasing load growth, Wisconsin's utilities must explore smart solutions to interconnection of DERs and related technologies

MSA Approval Landscape

02



Pathways to Approval

Utility Direct ~ 3-12 months

The utility approach aims to secure metering engineering and standards approval for use of meter adapters in the utility service territory, then either moving into a short testing period or moving directly onto sales deployment.

Regulatory ~ 9-18 months

The regulatory approach entails filing a petition with a state public utility commission asking them to issue an order that investor-owned utilities (IOU's) within the state must adopt a process for testing and approving meter socket adapters (MSA's).

Legislative ~ 12-18 months

The legislative approach involves either attaching language to an energy-related bill that is already in process, or finding a sponsor for a stand-alone MSA enabling bill. Similar to regulatory action, an MSA bill would require IOU's to adopt an MSA testing process.

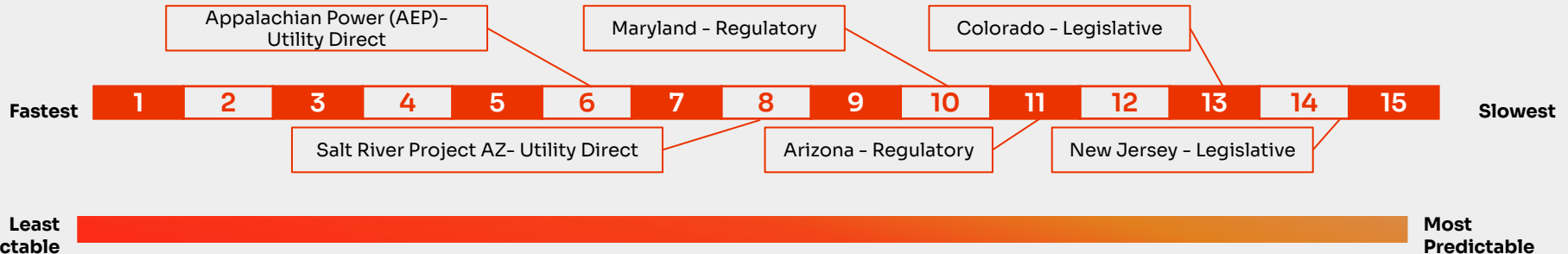

Approvals Map

- MSAs are approved for utilities covering 35 Million Residential customers
- In many states, all IOUs have approved MSAs
- Midwest
 - Comed IL approved, Ameren IL implementing
 - Evergy MO, KS
 - Several OH munis
 - Pending regulation updates in IA, OH

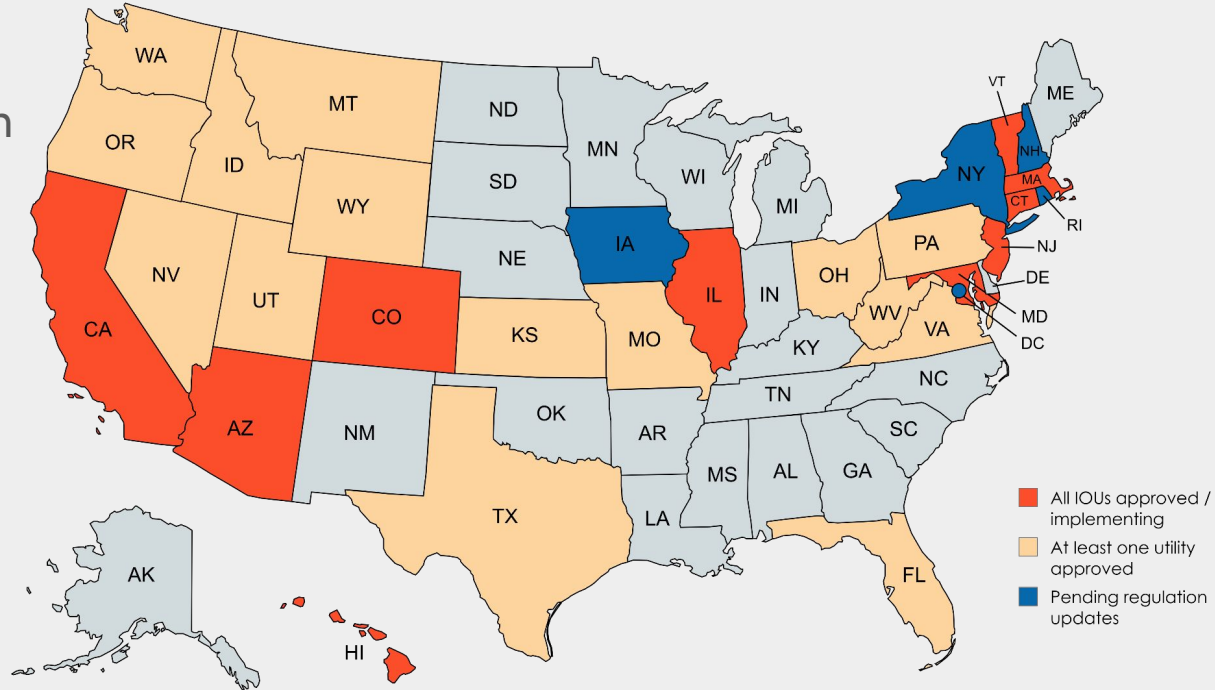

Wisconsin and MSAs

- At least two utilities have approved the Tesla Backup Switch (Eau Claire and Sturgeon Bay)
 - Similar to ConnectDER, Tesla's device is a customer-owned MSA, typically installed by a third-party electrician
- Xcel Energy has approved in their CO territory
- ConnectDER has not identified state rules restricting MSA usage: utilities may adopt their own rules without the need for state-level regulatory changes



ConnectDER at Feb. 2025 Renew WI Conference



Next Steps

03



How Do Utilities Implement MSA Processes?

- Complete review of documentation and optional review of a sample unit
- Update any relevant service standards, interconnection guidelines, interconnection application forms
- Publish approved models on utility website
- Notify MSA manufacturer (ConnectDER or others) of approval
- ConnectDER provides education to inspectors and AHJs following utility approval



Questions and Discussion

04

Appendix: What Documentation is Available?

- Product Technical Specification and Installation Manuals are publicly available on ConnectDER's website
 - <https://connectder.com/installers/> (near bottom of the page)
- Upon request, ConnectDER can provide a Product Toolkit directly to utilities. This includes:
 - NRTL Testing Summary
 - Functional Testing Results
 - Extended Lifecycle Testing

Thank you!

Please reach out to Emily Peck
with any questions,
epeck@connectder.com